









Single door 500KG Electromagnetic lock

EL-1200D, EL-1200S, EL-1200SD, EL-1200SZ, EL-1200ST

Specifications

EL-1200	Without indicator lights	
EL-1200S	With LED (Red only)	
EL-1200SD	LED, door sensor	 
EL-1200ST	LED, door sensor, Time delay	  
EL-1200SZ	LED, door sensor, Buzzer	  
Lock size	265Lx72Wx40H(mm)	
Armature Plate	185Lx60Wx13H(mm)	
Holding Force	500kg (1200Lbs)	
Voltage	DC12V or DC24V (adjustable)	
Current Draw	12V/420mA 24V/210mA	
Signal Output	Dry Contact, Max Rating of Contact Current 3A	
Surface Temp	≤20°C	
Operating Temp	-10°C ~ 55°C (14°F~131°F)	
Suitable Humidity	0~90%(non-condensing)	
Finishes for Shell	Anodized aluminum surface texture processing	
Finishes for Magnetic	Zinc	
Finishes for Armature	Zinc	
Weight	4.5kg	
Standard Packing	4pcs	

Dimensions

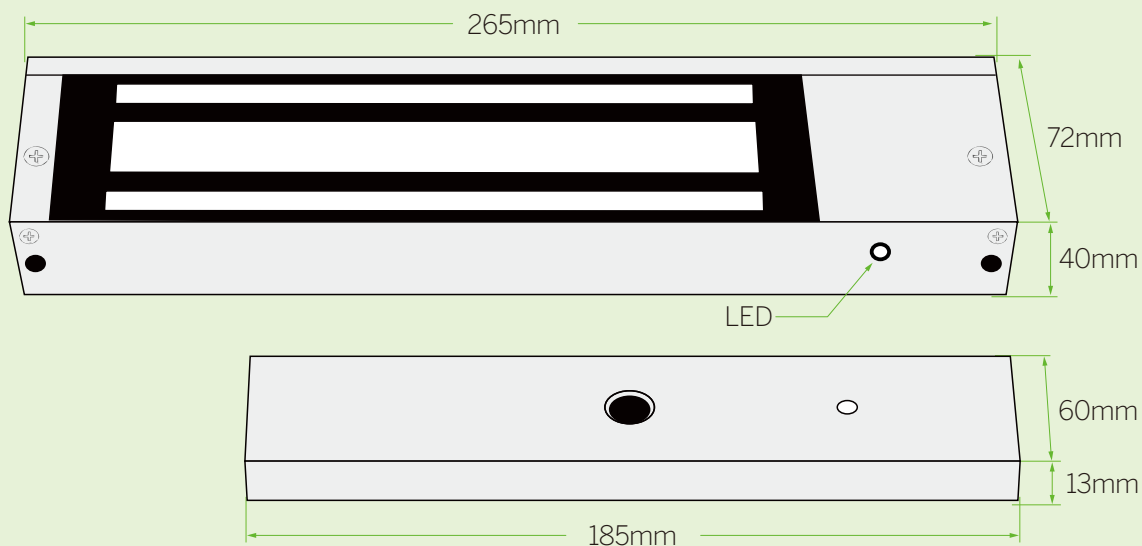

Wiring diagram

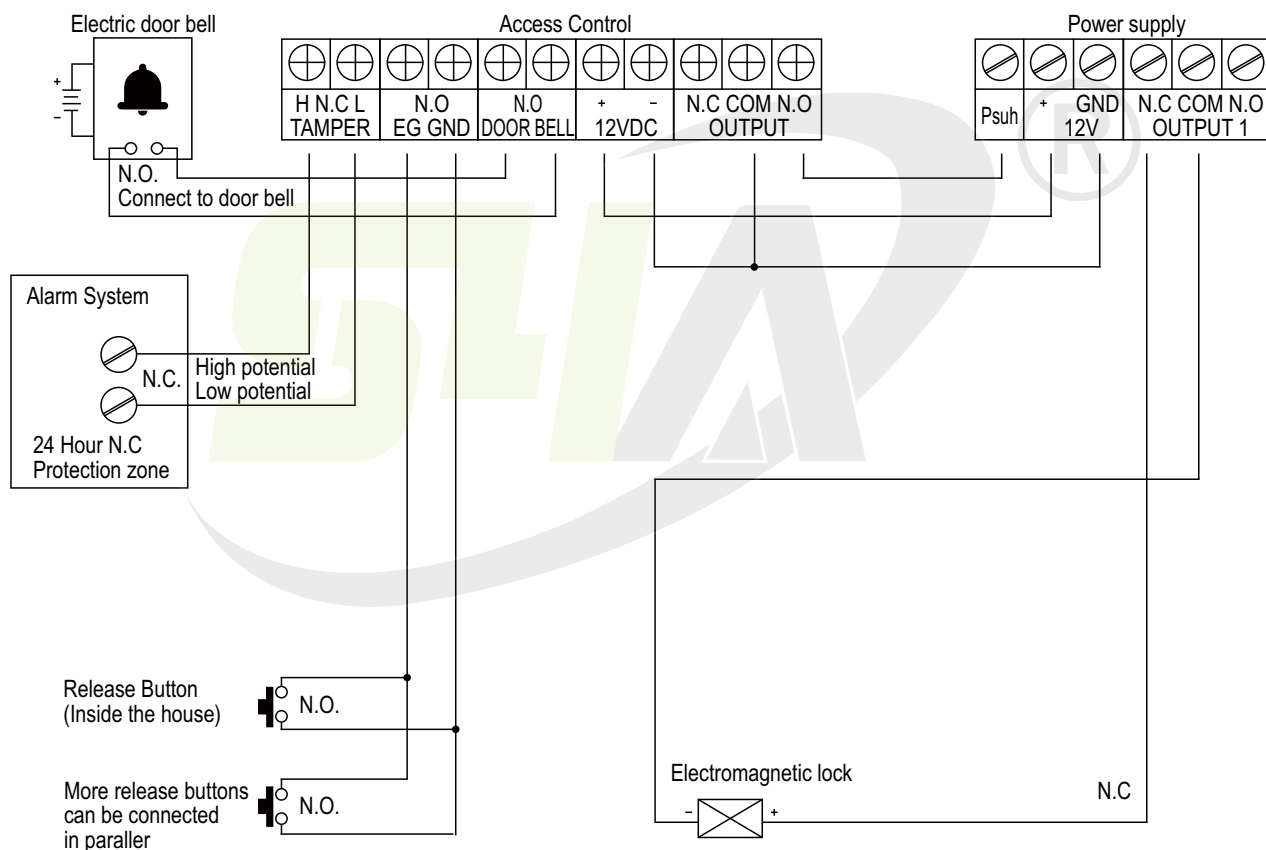

S4A Industrial Co., Limited

Address: 6th Floor, Haotai Industrial Zone, Minzhi road,
Longhua District, Shenzhen. CN 518131

Tel: +86 755 29450011

www.s4a-access.com / Email: sales@s4a-access.com
Mob/Whatsapp/Wechat/Viber: +86 134 1050 0721