



F7 Fingerprint Access Controller User Manual

F7-EM Simplified Instruction	
Function description	Choose from the relevant functions below and input
Enter the programming mode	*- 888888 - #, then you can do the programming (888888 is the default factory master code)
change the master code	0 - new code - # - repeat the new code - # (code: 6-8 digit)
Add fingerprint user	1- Fingerprint – repeat Fingerprint - # (can add Fingerprints continuously)
Add card user	1- Card - # (can add Cards continuously)
Delete user	2 – Fingerprint - # 2 – Card -# (can delete Users continuously)
Exit from the programming mode	*
How do release the door	
Fingerprint User	Put the Finger on the fingerprint sensor for 1 second
Card User	Read card



F7 Fingerprint& RFID Access Controller

1. Introduction

F7-EM supports fingerprint and EM RFID card. The performance has greatly improved.

The product uses the precise electron circuit and good productive technology, which is the metal structure fingerprint & card access machine. It is widely used in business affairs organization, office, factory, housing district etc.

The product use remote control or manager fingerprint for programming, support fingerprint and EM 125Khz card, easy to install and program.

2. Feature

- Metal case, anti-vandal
- Fingerprint access controller and reader, WG26 Input / output
- Capacity: 200 fingerprints and 500 cards
- Two accesses: card, fingerprint

3. Installation

- Remove the back cover from the device using the supplied security screw driver
- Drill 4 holes on the wall for screws and 1 hole for cable.
- Fix the back cover firmly on the wall with 4 flat head screws.
- Thread the cable through the cable hole
- Attach the device to the back cover

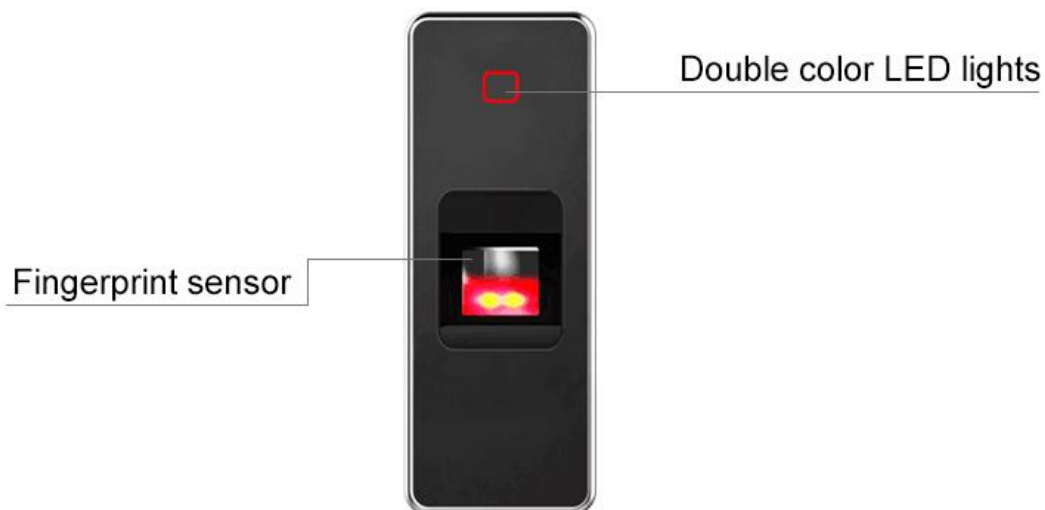

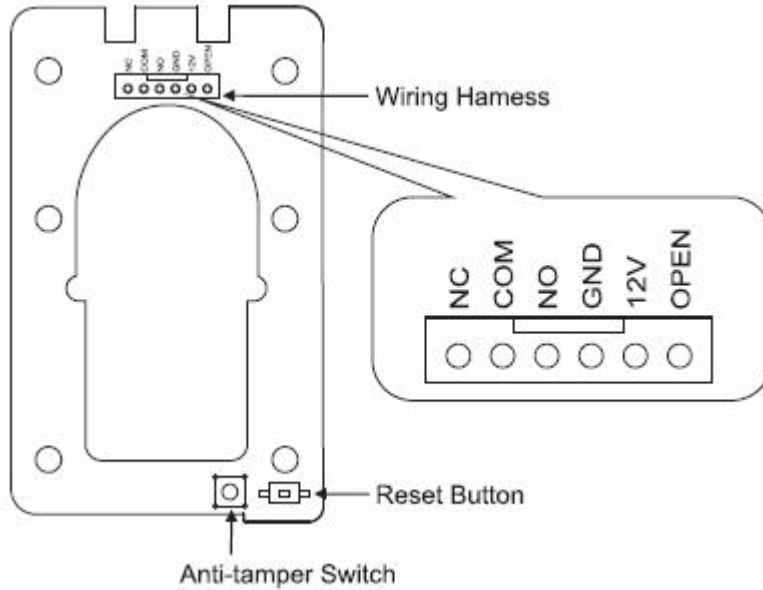

4.Wiring

No.	Color	Function	Description
1	Green	D0	Wiegand output D0
2	White	D1	Wiegand output D1
3	Grey	Alarm-	Alarm Negative
4	Yellow	Open	Request to Exit Button
5	Brown	D_IN	Door Contact
6	Red	+12V	(+) 12VDC Positive Regulated Power Input
7	Black	GND	(-) Negative Regulated Power Input
8	Blue	GND	Request to Exit Button& Door Contact
9	Purple	L-	Lock Negative
10	Orange	L+/Alarm+	Lock Positive/Alarm Positive

5. Connection Diagram

5.1 Common Power Supply

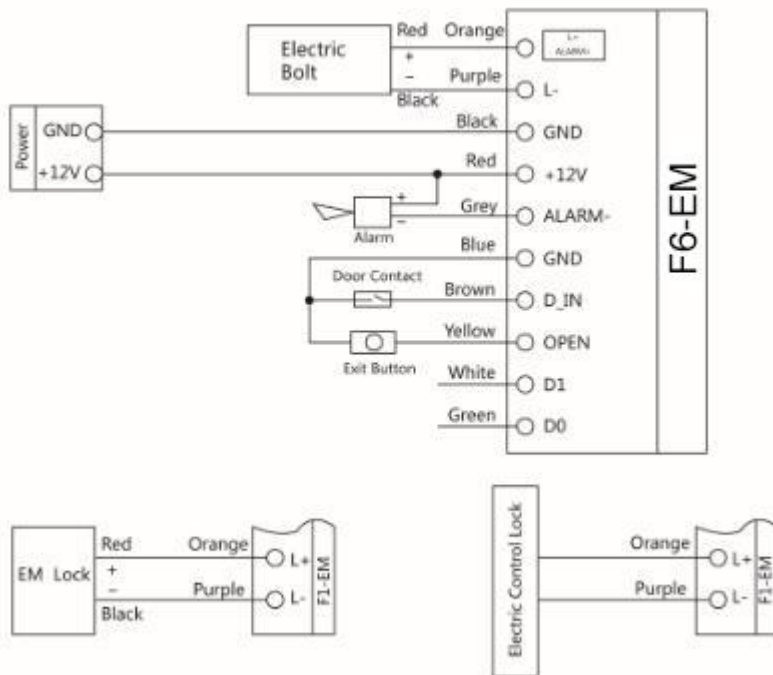

5.2 Special Power Supply

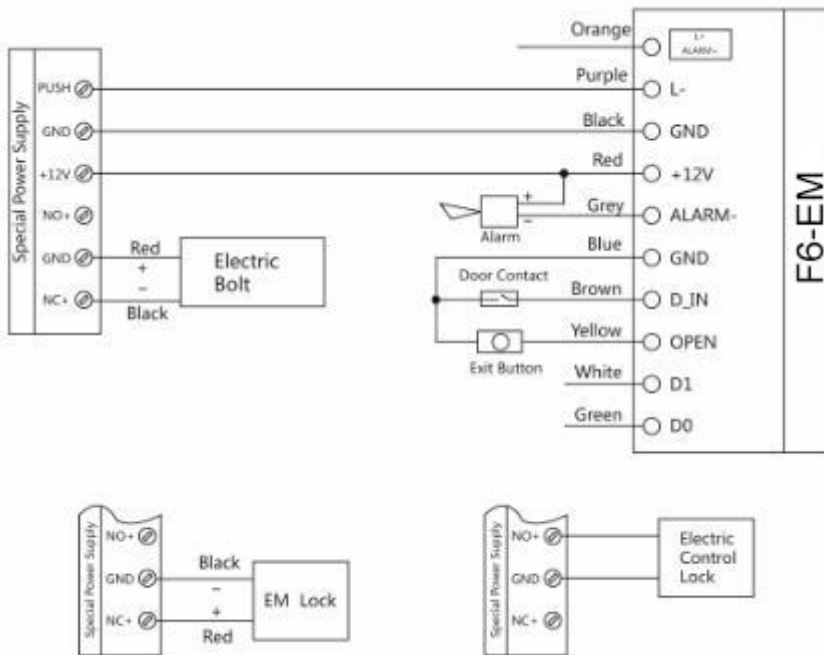

6. Manager Operation

There are 3 ways to add and delete users:

1. by manager card
2. by remote control



3. by manager fingerprint

6.1 By Manager Card (the most convenient way)

6.1.1 Add Fingerprint user

Manager add card Enter 1st User Fingerprint Twice 2nd User Fingerprint Twice ...
Manager add card

Note: When add fingerprint, please input each fingerprint twice, during which the LED shines red then turn green, means the Fingerprint is enrolled successfully. When delete fingerprint, just input it once

6.1.2 Add Card user

Manager add card 1st User card 2nd User card ... Manager add card

Remark: Fingerprint user ID is 3~1000, Card user ID is 1001~3000, when add fingerprint or Card by Manager card, it is produced automatically from 3~1000 or 1001~3000. (ID 1, 2 are belong to Manager Fingerprint)

6.1.3 Delete users

Manager delete card User card OR Fingerprint once ... Manager delete card

To delete more than 1 card or fingerprint, just input card or fingerprint continuously.

Note: When delete fingerprint, please input it once.

6.2 By Remote Control

6.2.1 Enter into Programming Mode:

* Master Code #. Default Master Code: 888888

Remarks: All the steps below must be done after enter into programming mode.

6.2.2 Add Users:

A. ID number -Auto generation

To add fingerprint users:

1 input one fingerprint twice #

To add more than one fingerprints, just input finger continuously

To add card users:

1 Card # Or 1 the Card Number (8 digit) #

To add more than one card, just input cards or card number continuously

Note: when add card users, it can just enroll the card number and don't have to enroll the card itself. The card number is the 8 digit printing on the card.

In the same way, when delete card users, it can just enroll the card number to delete it and don't have to get the card if it is lost.

B. ID number -Appointment

To add fingerprint users:

1 ID number # User Fingerprint #

Fingerprint User ID number can be any digit between 3-1000, but one ID number to one user

To add fingerprint users continuously:



1 3 # 1st User Fingerprint 4 # 2nd User Fingerprint... N # Nth User Fingerprint #

To add card users:

1 ID number # Card #

Or 1 ID number # the Card Number (8 digit) #

Card User ID number can be any digit between 1001-3000, but one ID to one Card

To add card continuously:

1 1001 # 1st Card 1002 # 2nd Card... N # Nth Card #

Or 1 1001 # 1st Card Number 1002 # 2nd Card Number... N # Nth Card Number

#

6.2.3 Delete users:

Delete fingerprint users:

2 fingerprint once #

Delete card users:

2 Card # Or 2 Card Number #

To delete users continuously: just input fingerprint or card continuously

6.2.4 If Delete users by ID:

2 User ID #

Remarks: When delete users, the Master can just delete its ID number and don't have to input fingerprint or card. It is the good option to delete if the users were left or cards lost.

6.2.5 Save and exit from the programming mode: *

6.3 By Manager Fingerprint

6.3.1 Enter into programming mode:

* Master Code #.

6.3.2 Add Manager fingerprint:

1 1 input fingerprint twice 2 # input another fingerprint twice *

ID number 1: Manager add fingerprint

ID number 2: Manager delete fingerprint

The first Fingerprint: Manager add Fingerprint, it is to add the users

The second Fingerprint: Manager delete Fingerprint, it is to delete users

6.3.3 Add user:

Fingerprint:

Manager add Fingerprint Input User Fingerprint twice Repeat Manager add Fingerprint

Card:

Manager add Fingerprint Card Repeat Manager add Fingerprint

6.3.4 Add users continuously

Fingerprint:



Manager add fingerprint 1st user fingerprint 2nd user fingerprint ... Nth user fingerprint

Manager add fingerprint

Card:

Manager add Fingerprint Card 1 Card 2 ... Repeat Manager add Fingerprint

6.3.5 Delete Fingerprint users

Manager delete fingerprint 1st user fingerprint 2nd user fingerprint ... Nth user Fingerprint

Manager delete fingerprint

6.3.6 Delete Card users

Manager delete fingerprint Card 1 Card 2 ... Card N

Manager delete fingerprint

6.4 Delete all the users

* Master Code # 20000 # *

Note: This will delete all fingerprints, cards, including Manager Fingerprint except Manager Card, before this operation it is suggested to make sure the data is un-useful.

6.5 Setting Facility Code

3 0~255 #

This operation might be required when F7-EM is acting as Wiegand reader and connecting to multi door controller

6.6 Setting Lock style and door relay time

Fail secure (unlock when power on)

* Master Code # 4 0~99 #

Fail safe (unlock when power off)

* Master Code # 5 0~99 #

Remarks:

1. In programming mode, press 4 is to choose Fail Secure lock, 0~99 is to set door relay time 0-99 seconds; press 5 is to choose Fail Safe lock, 0~99 is to set door relay time 0-99 seconds.
2. Factory default setting is Fail safe lock, relay time 5 seconds.

6.7 Setting door open detection

* Master Code #

6 0 # to disable this function (factory default setting)

6 1 # to enable this function

When enable this function:

- a) If open the door normally, but not closed after 1 minute, the inside Buzzer will alarm automatically, the alarm will be off itself after 1 minute
- b) If the door was opened force, or the door was not opened in 120 seconds after lock was released, the inside Buzzer and outside Siren will both alarm.



6.8 Setting Security Status

* #

Normal status:

(Factory default setting)

Lock on status:

#

If there is 10 times invalid card or wrong Password in 10 minutes, the device will lock on for 10 minutes.

Alarm status:

#

If there is 10 times invalid card or wrong Password in 10 minutes, the device will alarm.

6.9 Setting Two devices interlocked

* #

to disable this function (factory default setting)

to enable this function

6.10 Setting Alarm signal output time

* # #

Alarm time is 0-3 minutes, factory default setting 1 minute.

7. User Operation

7.1 User to release the door

Card user:

Fingerprint user:

7.2 Remove Alarm

When the device is in alarm(from built-in buzzer OR from alarm equipment outside), to remove it:

Or

Or

8. Advanced Application

8.1 F7-EM works as slave reader, connecting to Controller

F7-EM supports Wiegand output, it can be connected to the controller which support Wiegand 26 input as its slave reader, the connection diagram is as figure 1

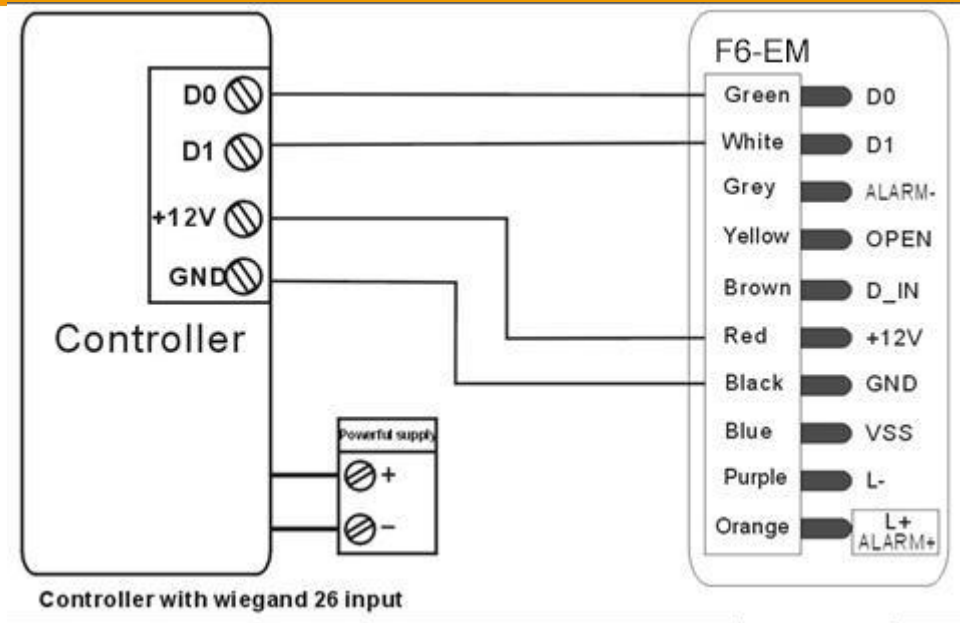

If the controller is PC connection, the users ID can be shown in the software.

- a) Card user, its ID is the same as the card number;
- b) Fingerprint user, its ID is the combination of device ID and fingerprint ID

The device ID is set as below:

* # #

Note: Device ID can be any digit of 0-255

For example: device ID was set 255, fingerprint ID is 3, then its ID to the controller is 255 00003.

8.2. F7-EM works as Controller, connecting slave reader

F7-EM supports Wiegand input, any card reader which supports Wiegand 26 interface can connect to it as its slave reader, no matter it is EM card reader or MIFARE card reader. The connection is showed as Finger 2. When add cards, it is required to do it at the slave reader, but not controller(except EM card reader, which can be added on both reader and controller)

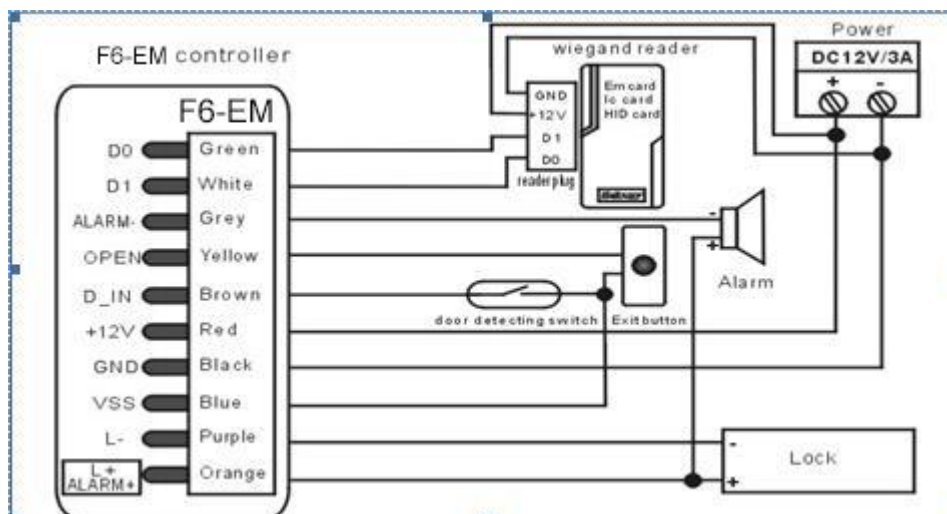



8.3. Two device interconnected - Single Door

Wiegand output, Wiegand input: The connection is showed as Figure 3. One F1-EM installed inside the door, the other outside the door. Either device acts as the controller and reader at the same time. It has below feature:

8.3.1 Users can be enrolled on either of the device. The information of the two devices can be communicated. In this situation the user capacity for one door can be up to 6000. Each user can use fingerprint or password for access.

8.3.2 The setting of the two F6-EM must be the same. If the master code was set different, the user enrolled in the outdoor unit can't access from outside.

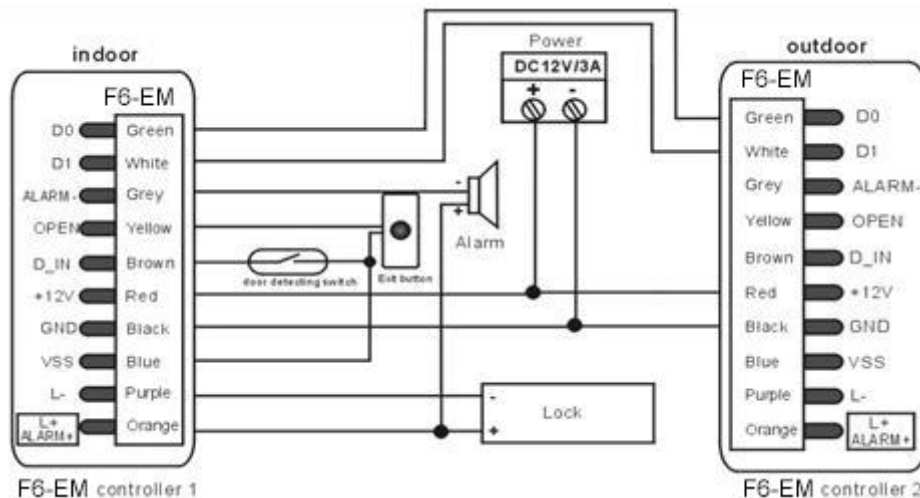

8.4. Two device interconnected & interlocked – Two Doors

The connection is showed as Figure 4, for the two doors, each door install one controller and one lock related. The interlocked function will go when either door is opened, the other door is locked forced, only close this door, the other door can be opened.

The interlocked function is mainly using in bank, prison, and other places where require higher security. Two doors are installed for one access.

The user enters fingerprint or card on controller 1, the door 1 will open, the user enters, and close door 1, only after that, the user can open the second door by entering fingerprint or card on second controller.

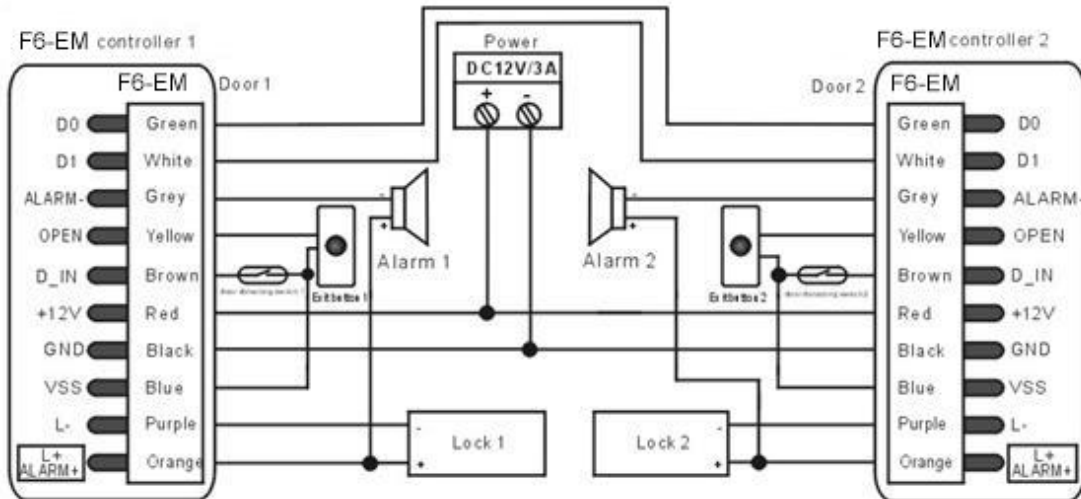

9. Reset to Factory Default

Power off, press the RESET key (SW14) on the PCB, hold it and power on, release it until hear two short beeps, the LED shines in orange, then read any two EM cards, the LED will turn in red, means reset to factory default setting successfully. Of the two EM cards read, the first one is Manager Add Card, the second one is Manager Delete Card.

Remark: Reset to factory default setting, the users's information enrolled is still retained. When reset to factory setting, the two manager cards must e re-enrolled.

10. Sound and Light indication

Operation Status	LED	Finger Sensor	Buzzer
Reset to factory default setting	Orange	-	Two short Ring
Sleeping mode	Red shines slow	-	-
Stand by	Red shines slow	Shine	-
Enter into programming mode	Red shines	-	Long Ring
Exit from programming mode	Red shines slow	-	Long Ring
Wrong operation	-	-	3 Short Ring
Open the door	Green shines	-	Long Ring
Alarm	Red shines fast	-	Alarm

11. Technical Specification

Article	Data
Input Voltage	DC 12V±10%
Idle Current	≤20mA
Active Current	≤80mA
User Capacity	Fingerprint:1000; Card:2000
Card Type	EM 125KHz card
Card Reading Distance	3~6CM
Operating	-20℃-50℃



Temperature	
Operating Humidity	20%RH-95%RH
Resolution	450 DPI
Fingerprint Input Time	<1S
Identification Time	<1S
FAR	<0.0000256%
FRR	<0.0198%
Structure	Zinc Alloy
Dimension	115mm×70mm×35mm

12. Packing list

Description	Quantity	Remark
F7-EM	1	
Infrared remote control	1	
Manager card	2	Manager Add Card &Delete Card
User Manual	1	
Security Screws (Φ3*7.5mm)	1	To fix the device to the back cover
Screw driver	1	
Self tapping screws (Φ4*25mm)	4	Used for fixing
Pastern stopper (Φ6*25mm)	4	Used for fixing
Diode	1	IN4004